

# INSTRUCTIONS

# TYCO<sup>®</sup> SUPER BLOCKS<sup>™</sup>

431 PIECE Castle Building Set

WORKS  
WITH LEGO<sup>®</sup>



Tyco Super Blocks connect to Lego<sup>®</sup> blocks and Tyco Pre-School Super Blocks.  
\*Lego<sup>®</sup> is a registered trademark of Interlego A.G.

These instructions will show you how to build the castle pictured on your set's package. Following these steps will show you how the Tyco super block castle pieces work together. After you've seen how we built our castle you will be able to use your imagination to make up your own designs for towers and castles. That's really the best part of your Tyco super blocks.

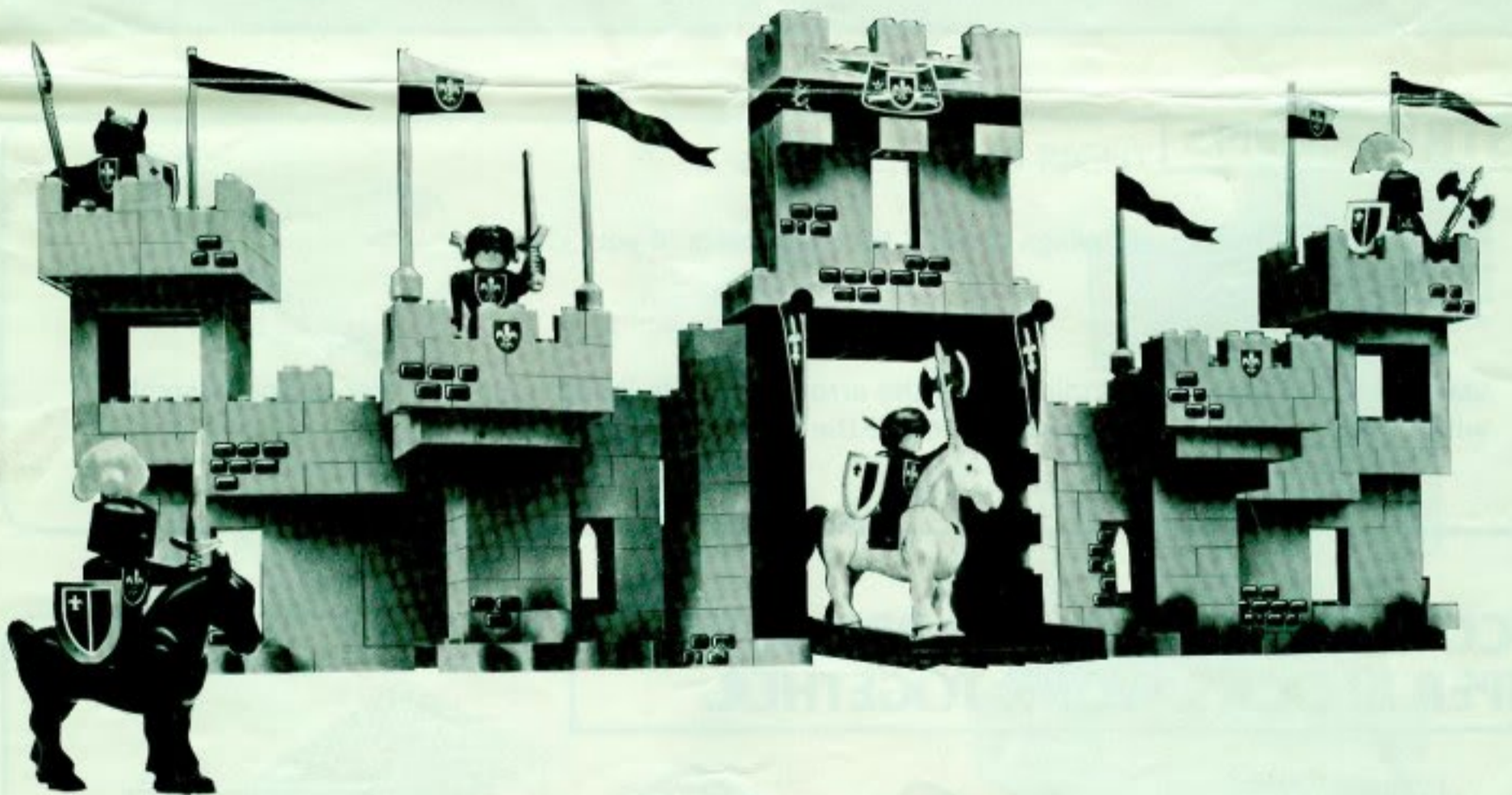

**TYCO SUPER BLOCKS ARE SAFE, CREATIVE, FUN.**

TYCO "Standard Size" SUPER BLOCKS are intended for use by children 4 years of age and older. As with any toy construction set, TYCO SUPER BLOCKS contain many small parts that must be kept away from children under 3.

# TYCO SUPER BLOCKS CASTLE PIECES

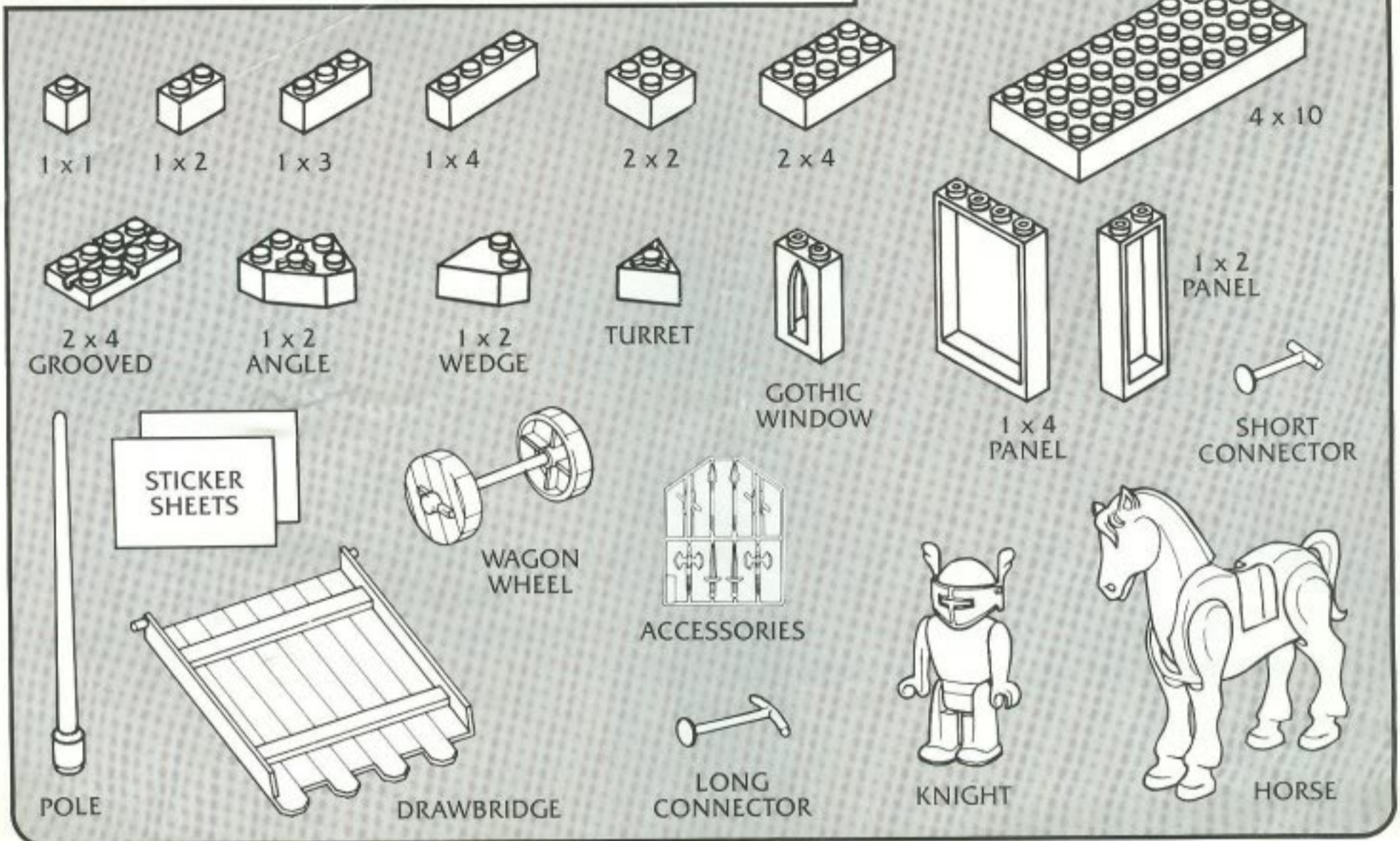

## INSTRUCTIONS

Follow the step by step drawings to build the main parts of your castle:

- Left and right front walls
- Left and right side walls
- Central gate tower or cap

Start each part at the step indicated by the arrow. After building the parts refer to final assembly which shows how they fit together to make the complete castle.

## TYCO'S STANDARD AND PRE-SCHOOL SUPER BLOCKS WORK TOGETHER.

BOTTOM VIEW OF ADAPTER BLOCK

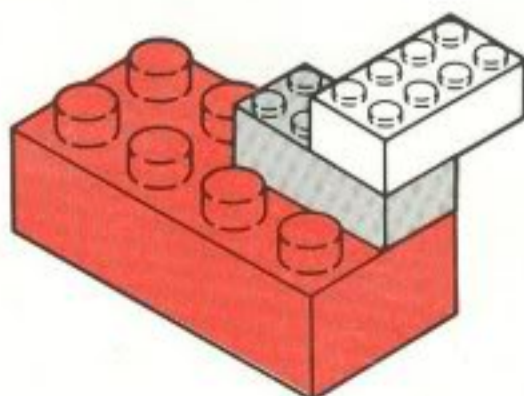

TYCO STANDARD

TYCO ADAPTER BLOCK

TYCO PRE-SCHOOL

# LEFT FRONT WALL

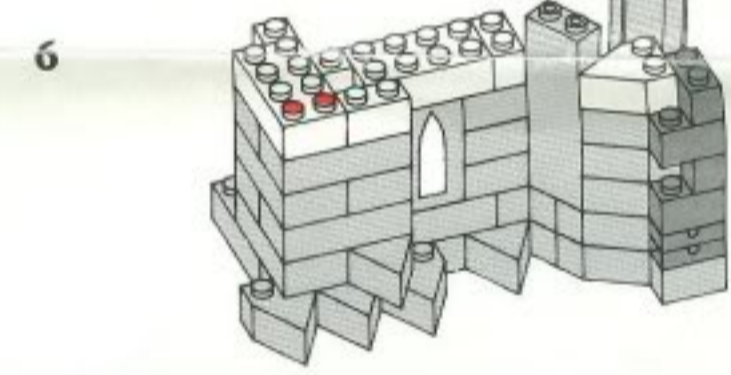
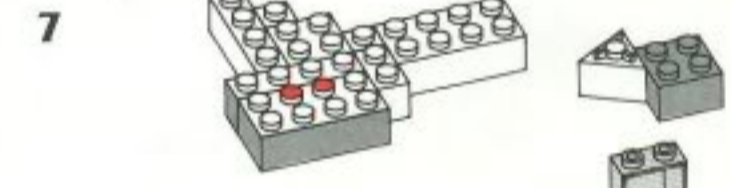
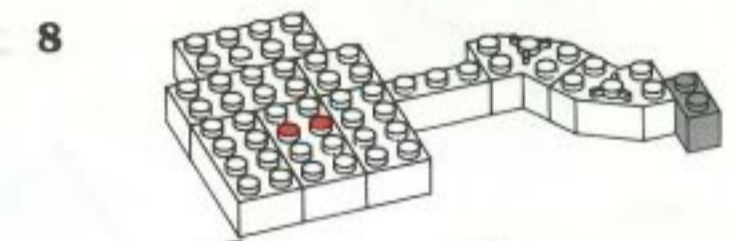
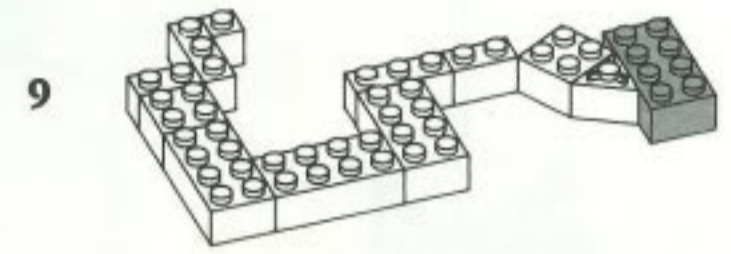
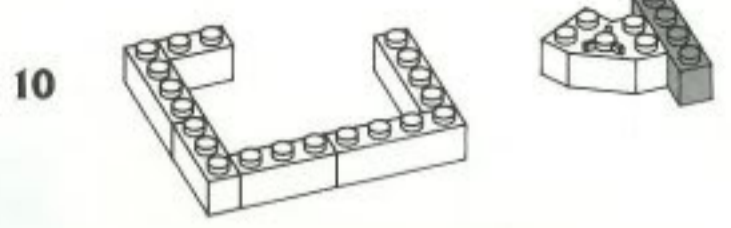
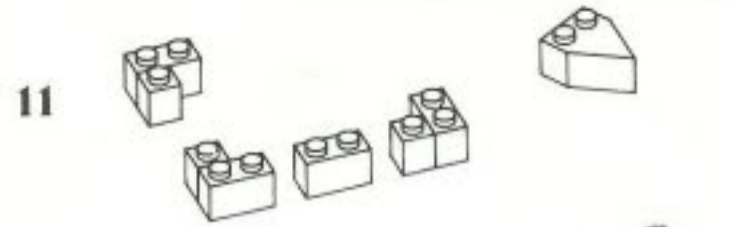
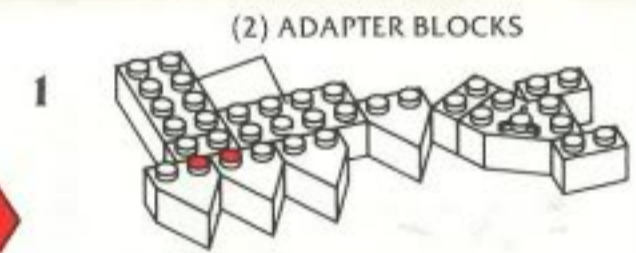
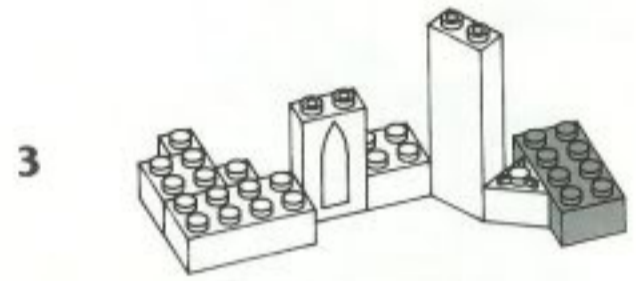
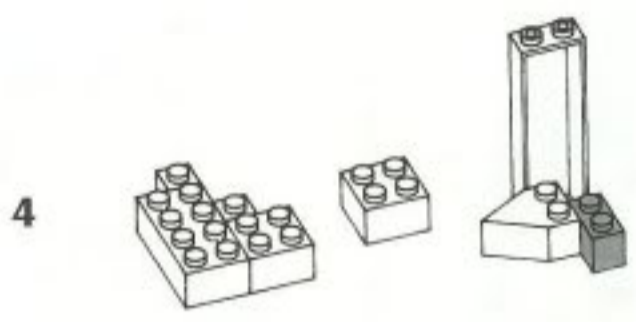
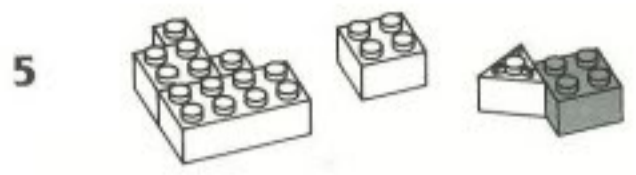

# CAP

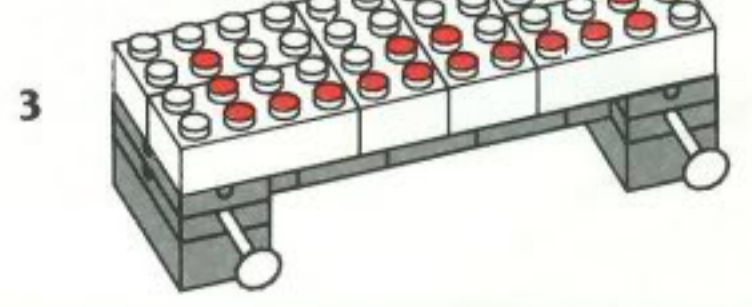
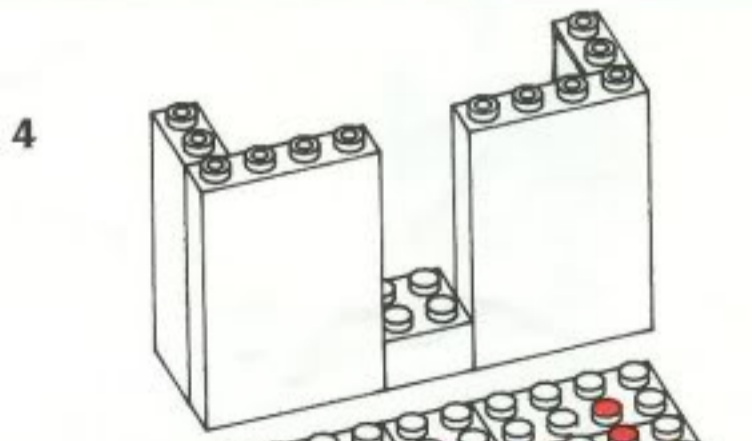
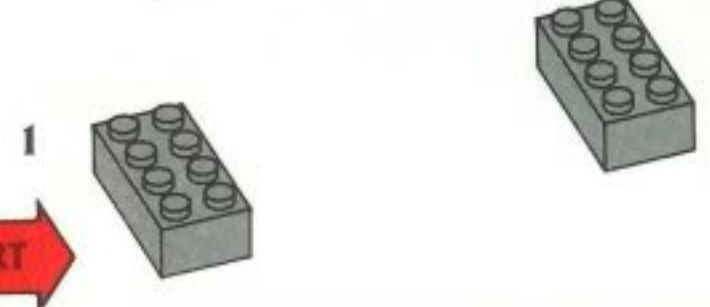
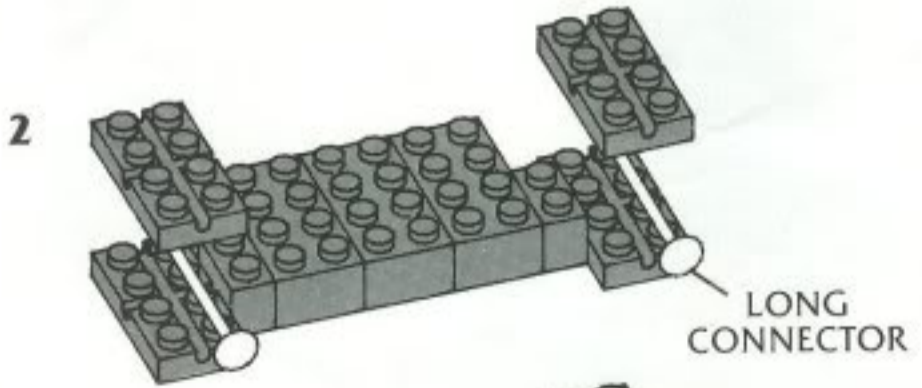

# RIGHT FRONT WALL

## ASSEMBLED LEFT FRONT WALL

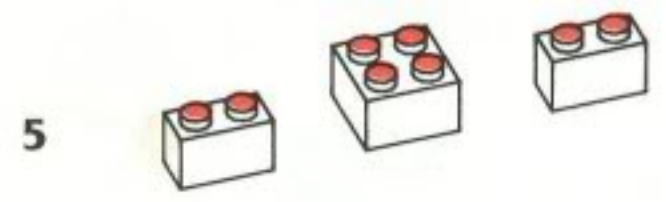
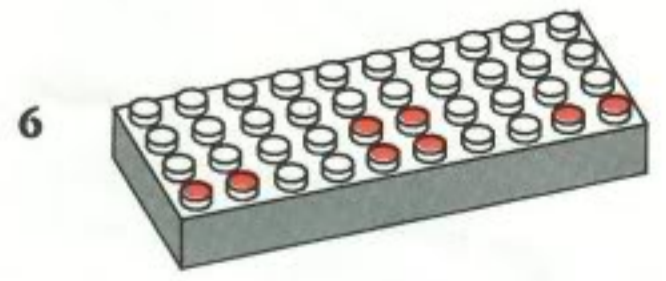
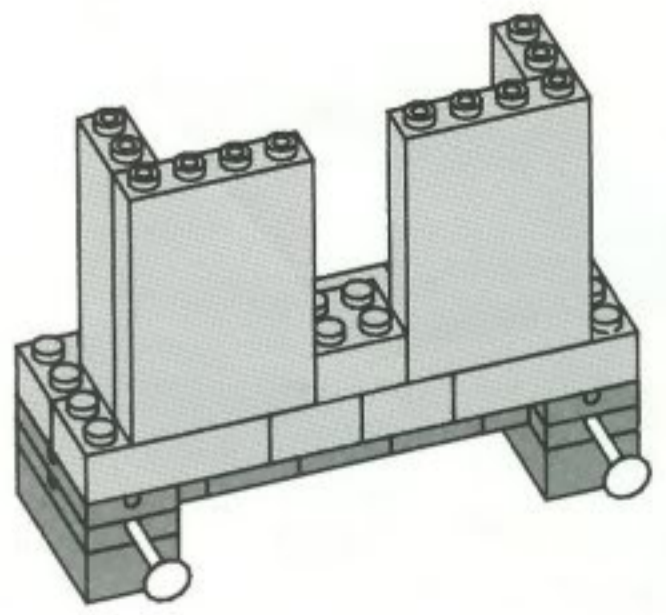
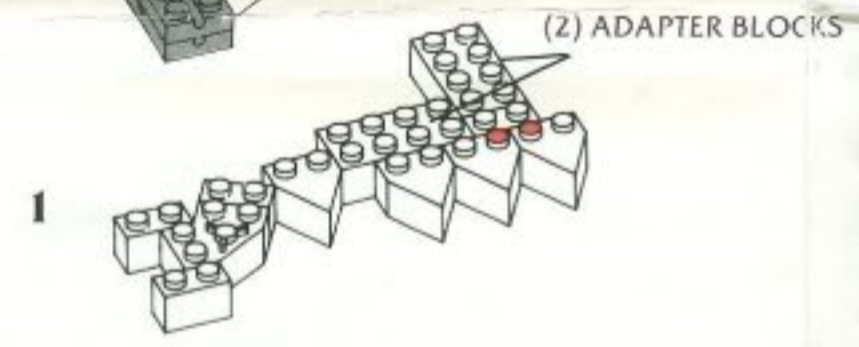
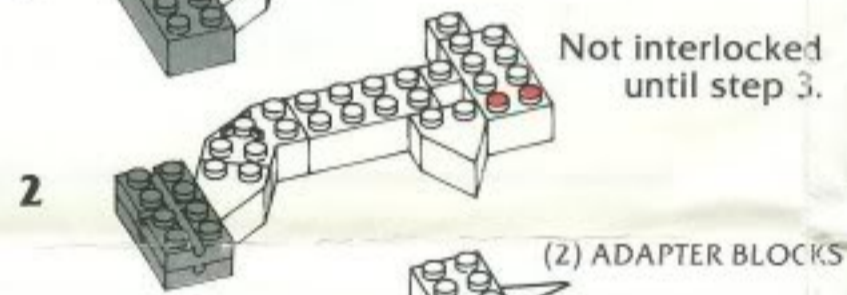
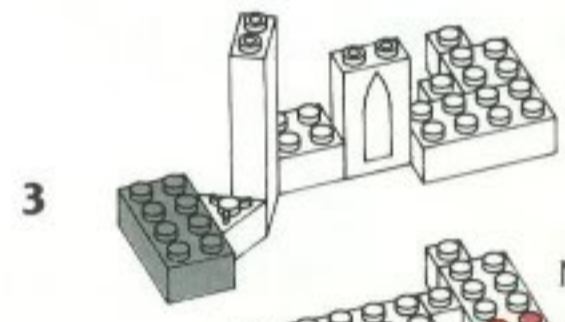
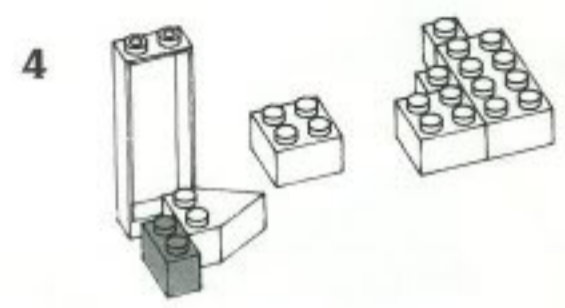
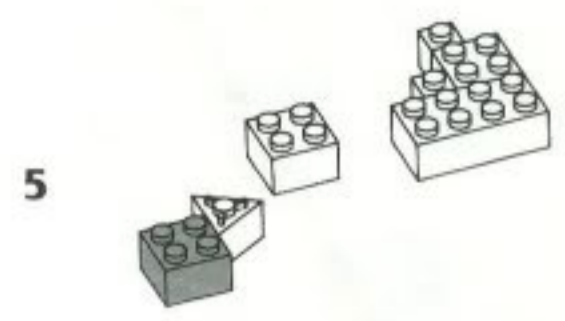
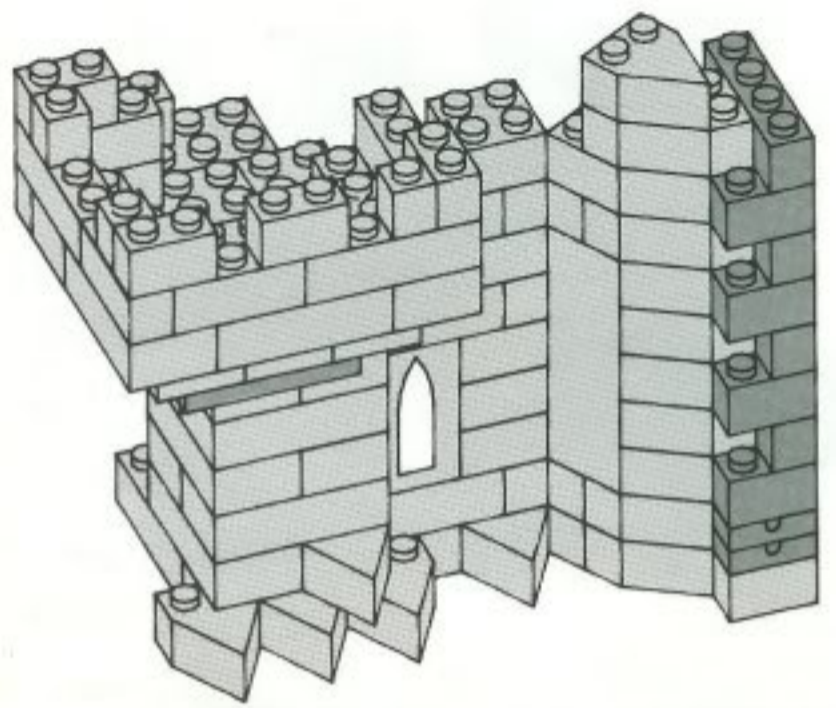

11

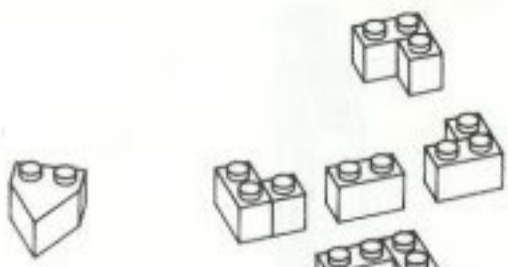

10

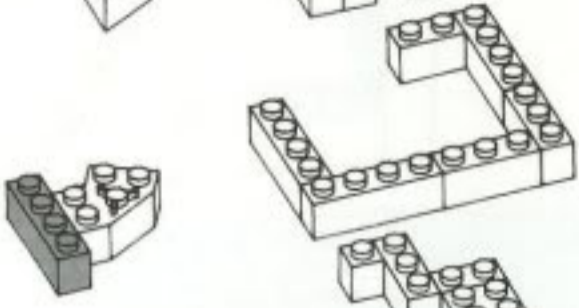

9

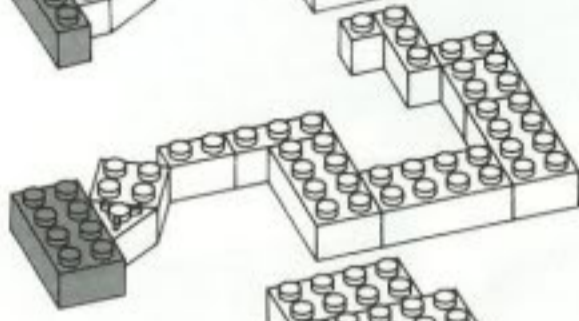

8

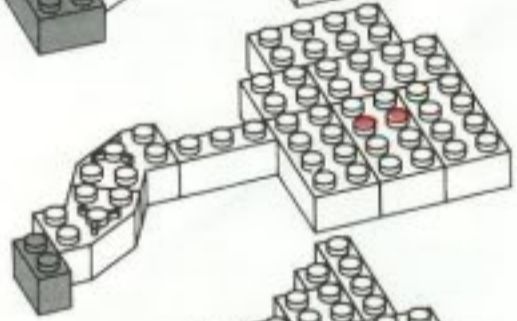

7

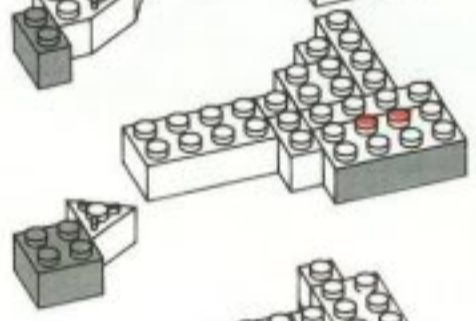

6

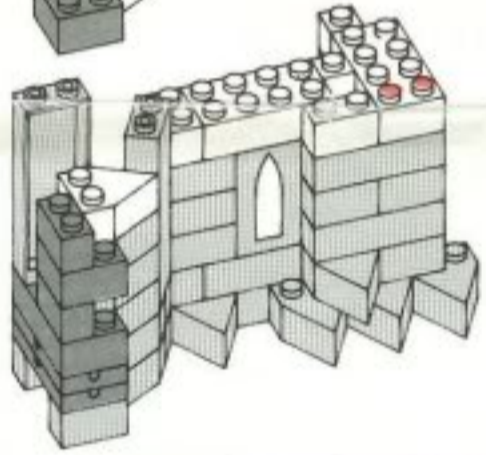

ASSEMBLED RIGHT FRONT WALL

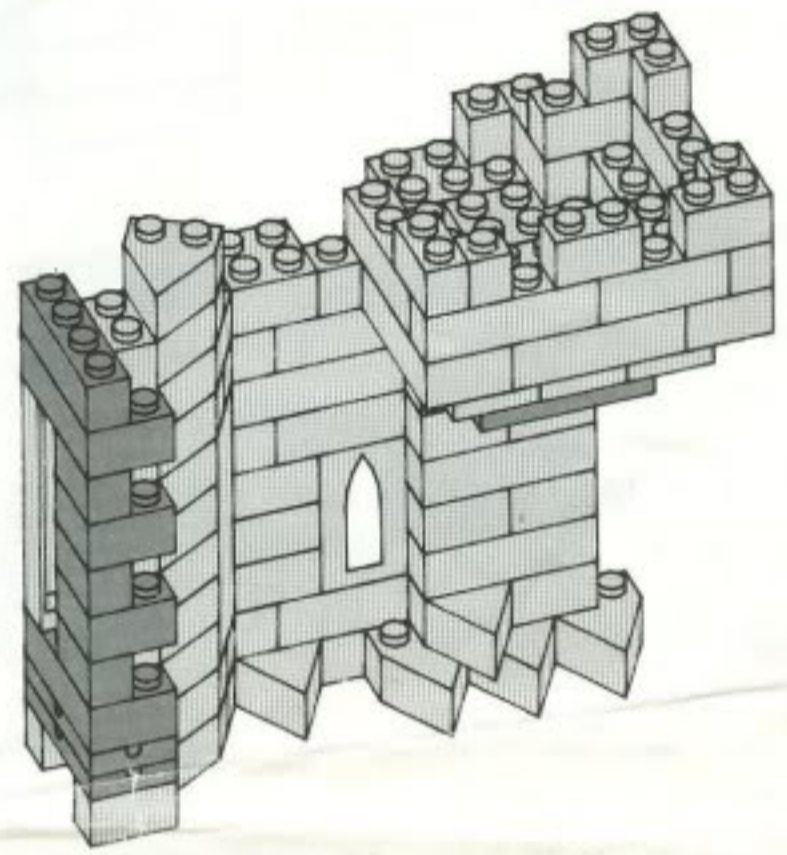

ASSEMBLED CAP

8

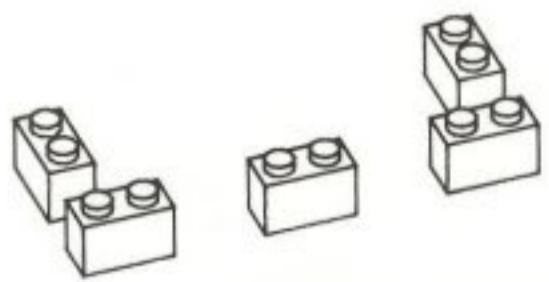

7

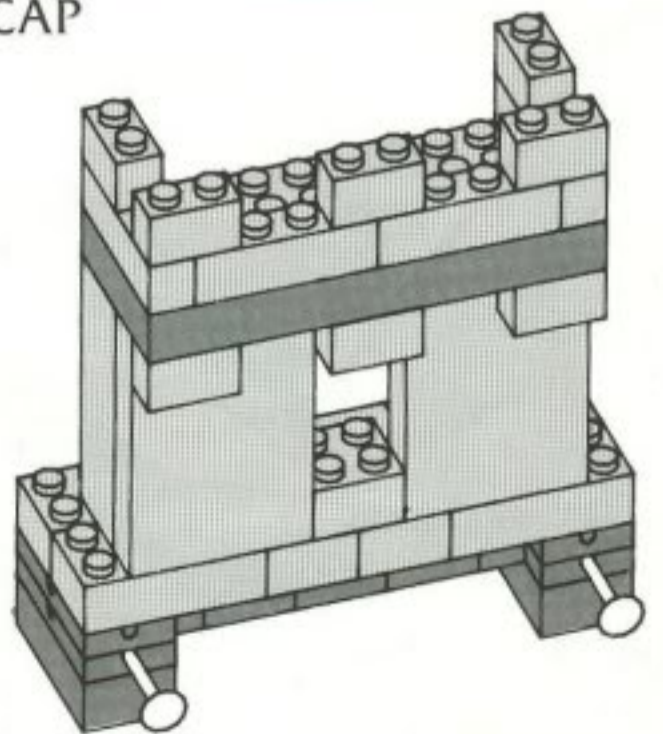
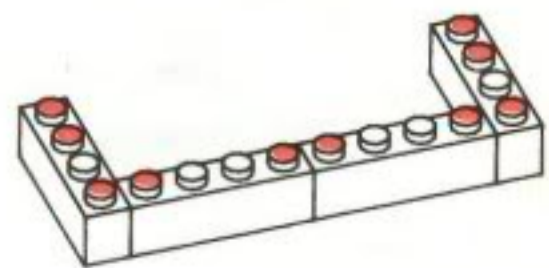

# LEFT SIDE WALL

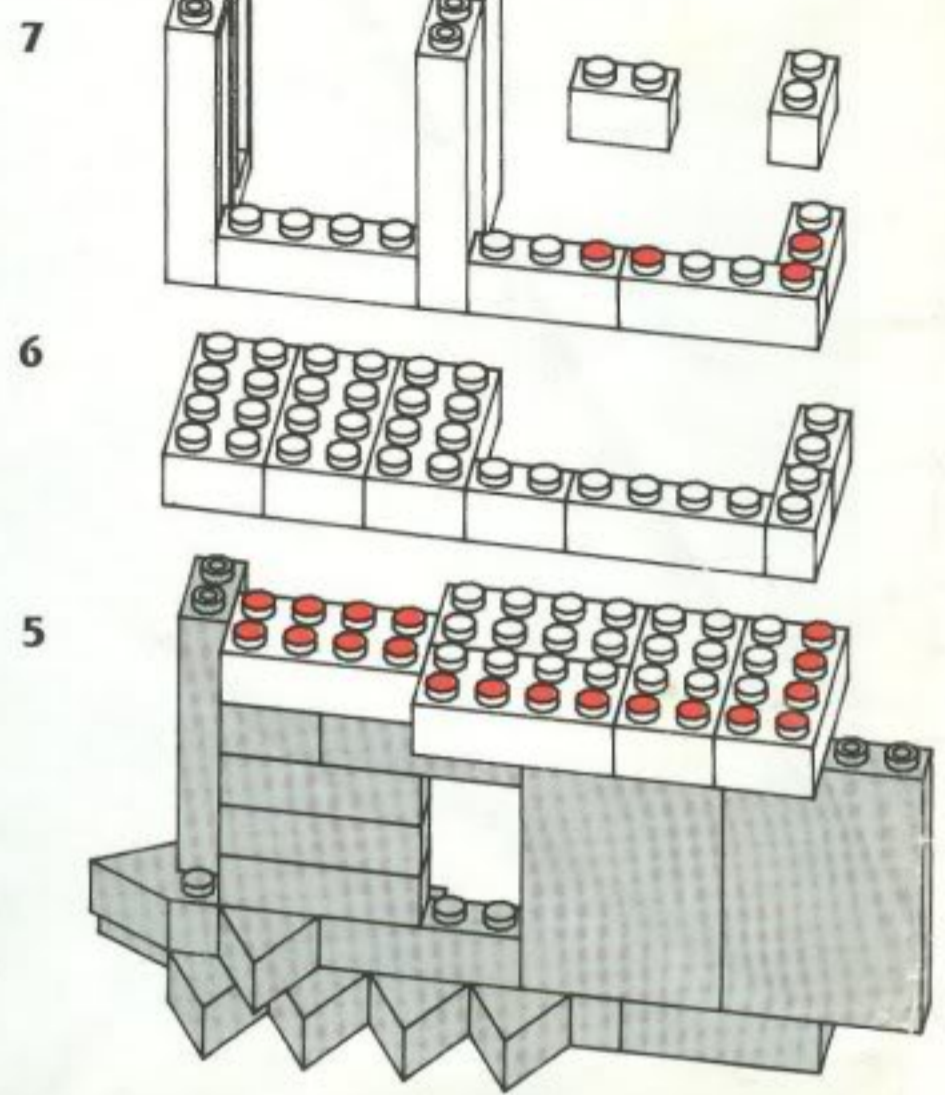
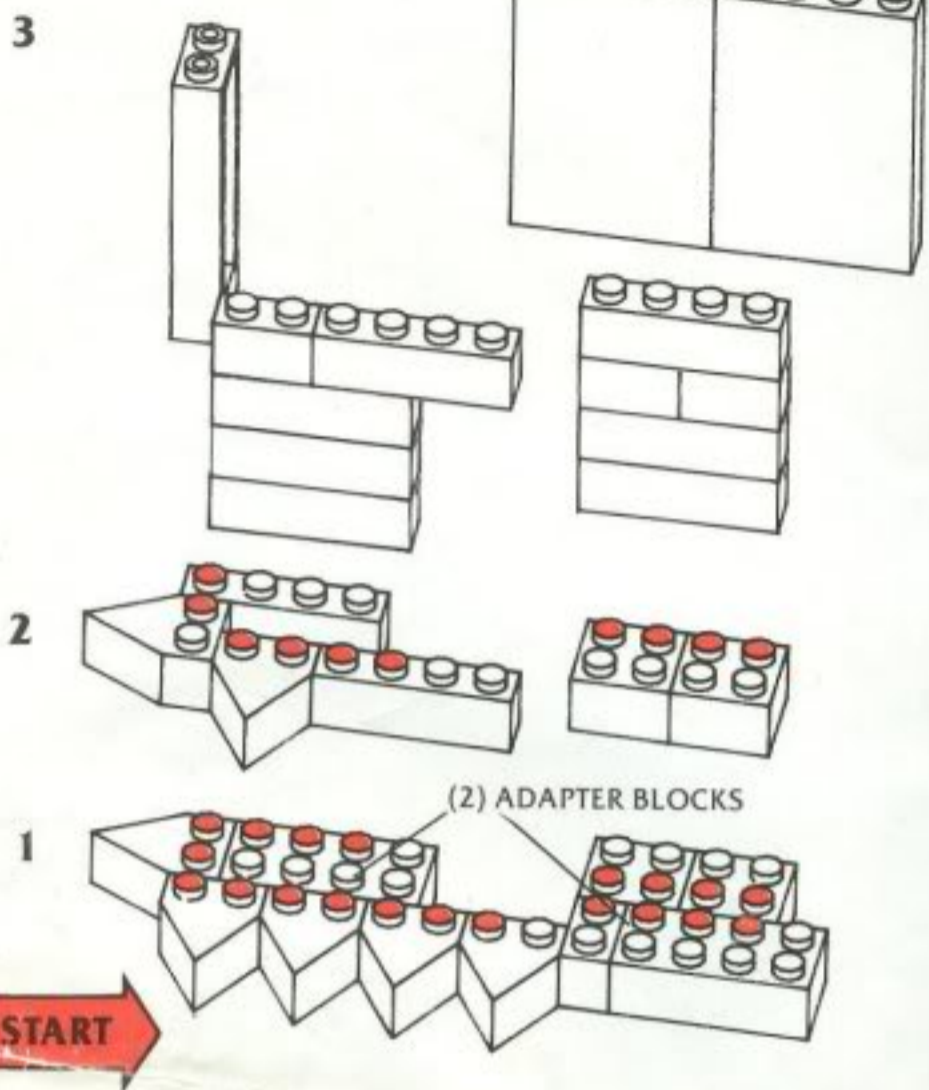

# RIGHT SIDE WALL

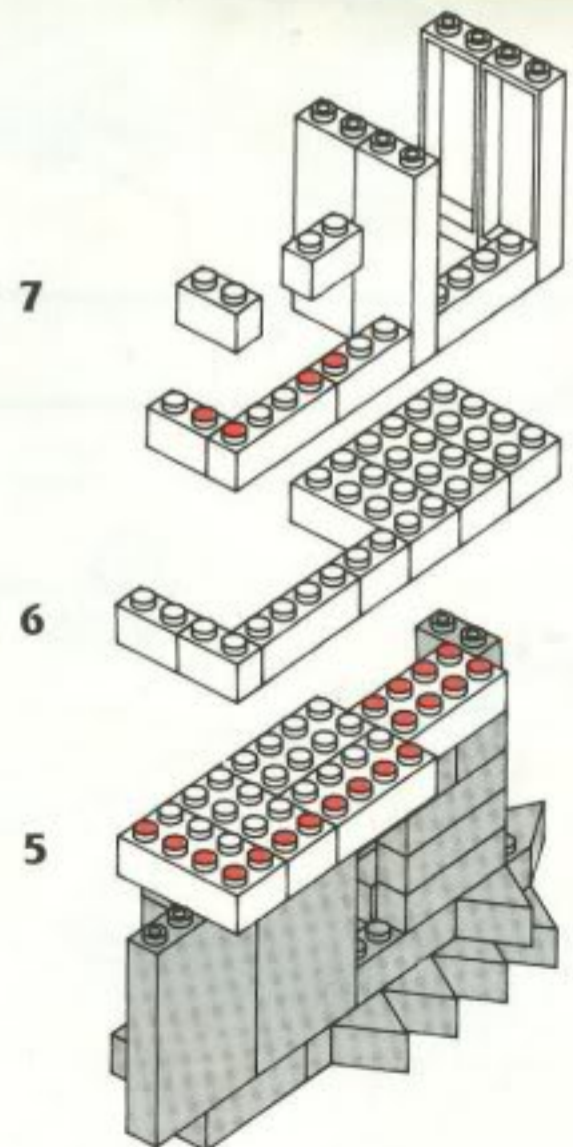
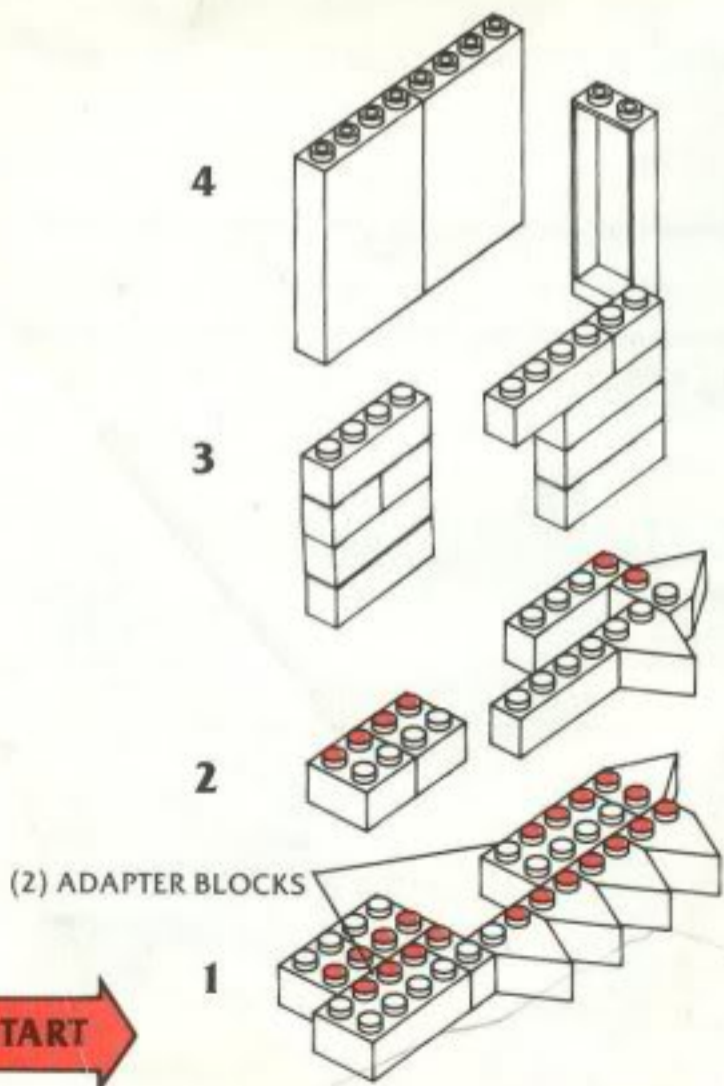

# ASSEMBLED LEFT SIDE WALL

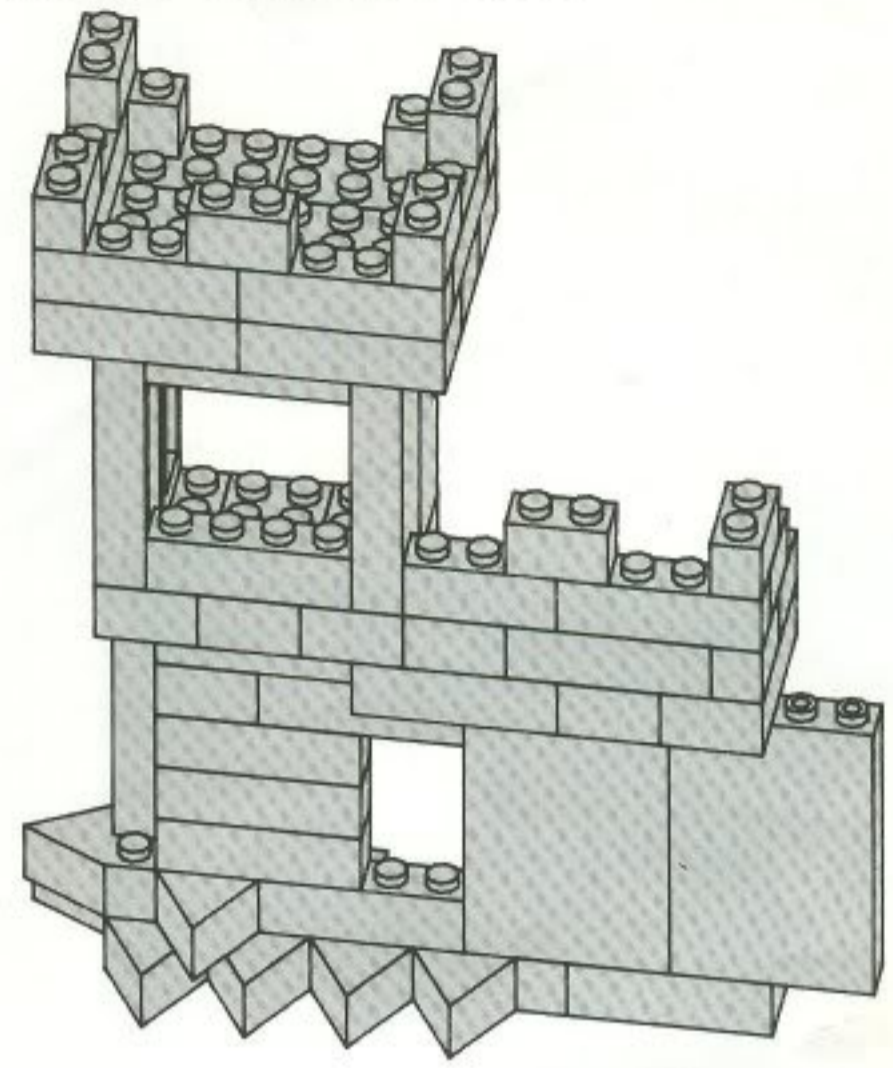
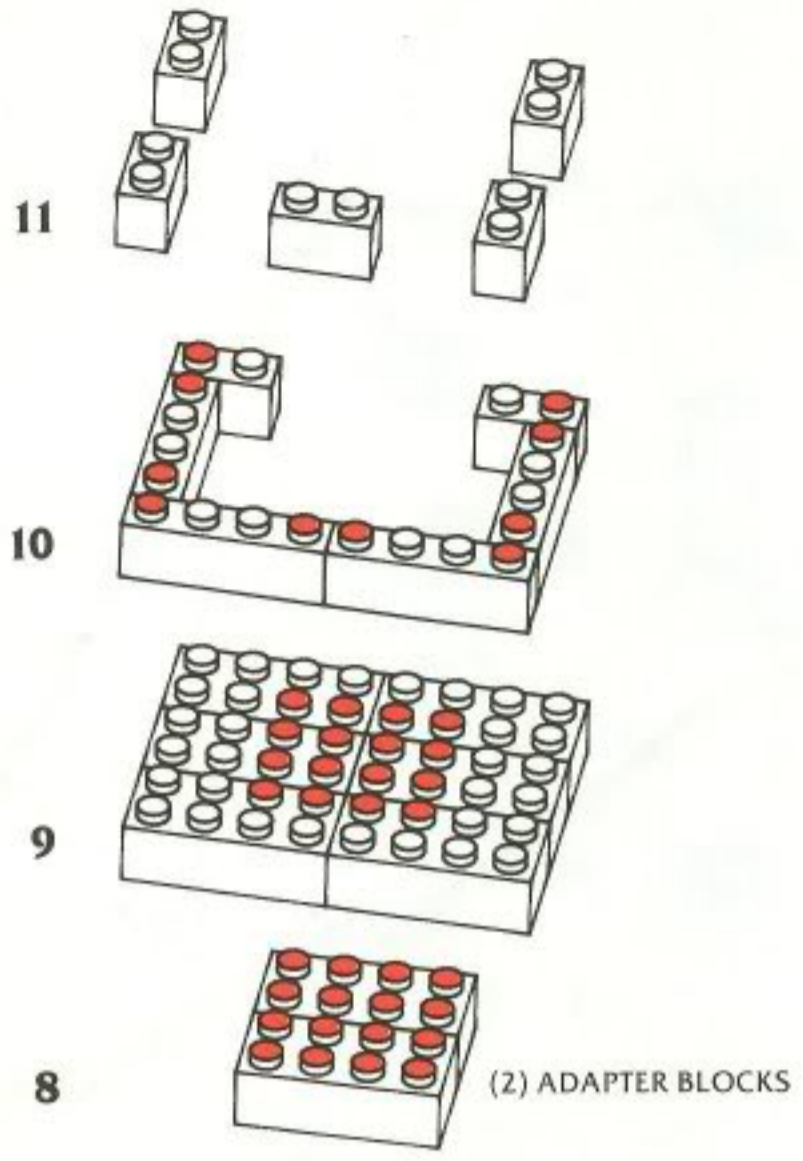

# ASSEMBLED RIGHT SIDE WALL

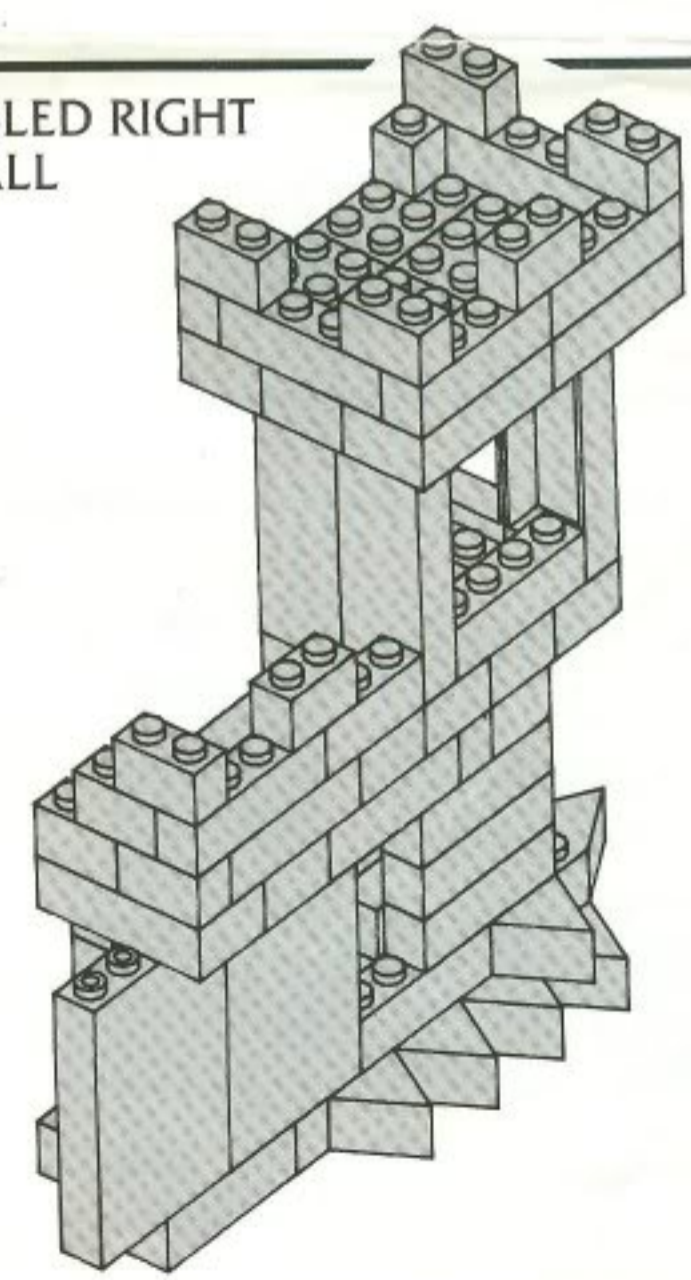
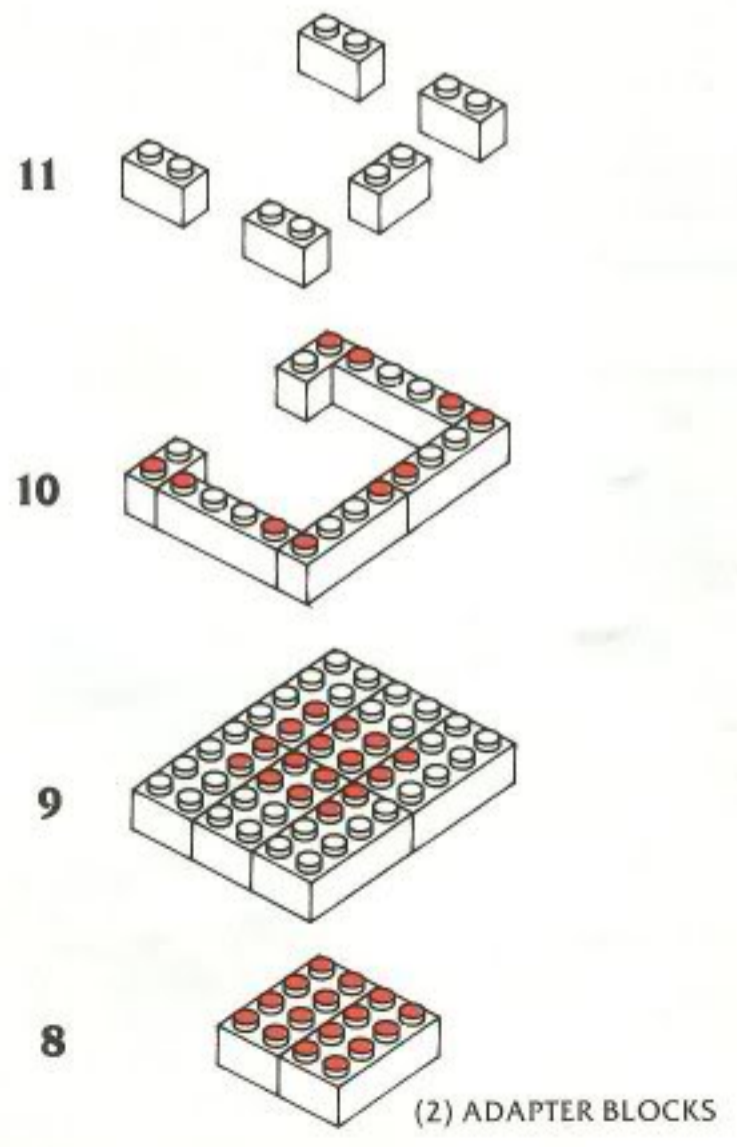

# FINAL ASSEMBLY

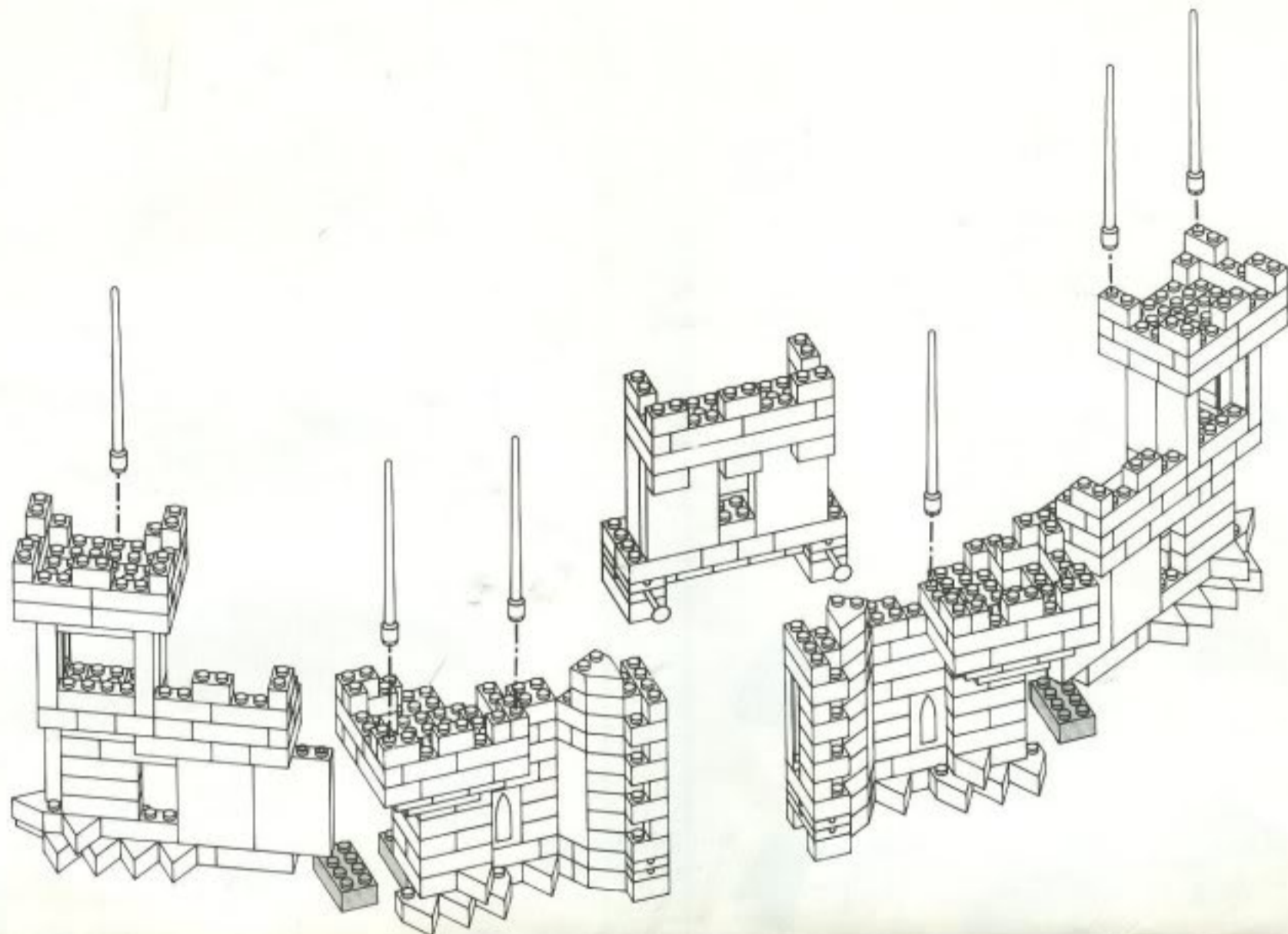

Remove corner block from left and right front walls and place corner block under panel of side wall as shown. Reassemble front wall onto side wall corner block.

## ASSEMBLED CASTLE

Remove Flags and Crest from sticker sheet and apply as shown on cover photo.

